

Kesit A-B

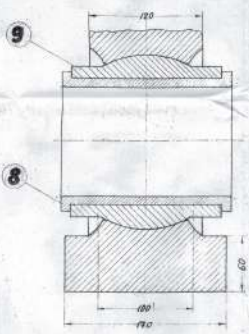

Kesit C-D

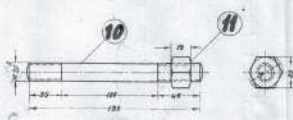
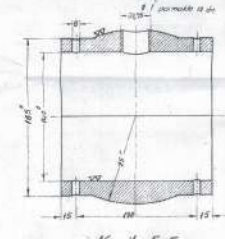
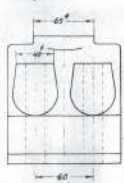
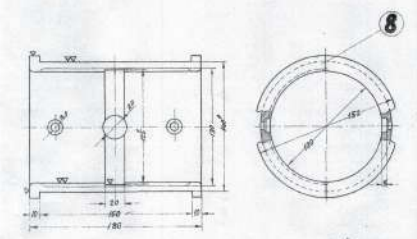
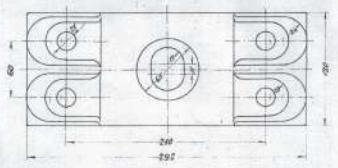
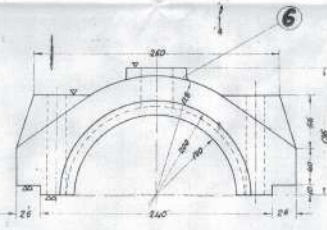
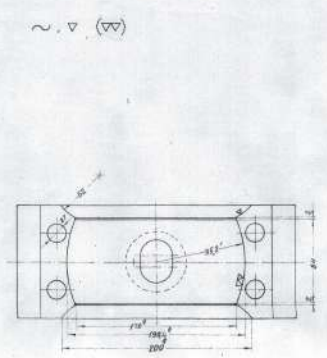

Kesit E-F

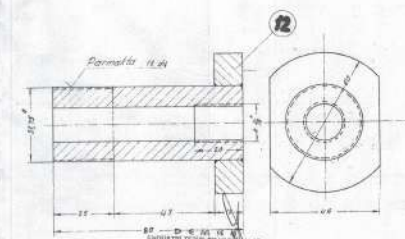
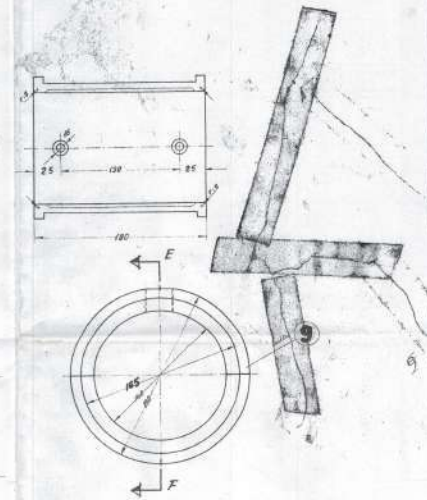
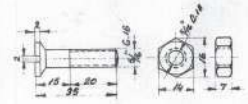
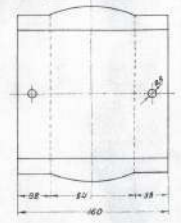

YATIRILAN TEKNİK VE MİMARLIK MÜHÜRÜ
MÜHÜRÜ VE MARMARİTİK LİMİTED
KURUMU'NA İZİN VERİLMİŞTİR.
TARİH: 15.05.2014

Teknik resimlerin yapımında kullanılan yazı fontları

4	12	Yatır. Kuvveti	52 25
12	14	Yatır. Kuvveti	52 42
18	10	Yatır. Kuvveti	52 42
4	8	Yatır. Kuvveti	52 42
4	8	Yatır. Kuvveti	52 42
4	8	Yatır. Kuvveti	52 42
4	8	Yatır. Kuvveti	52 42
Adet	parça №	Parça Adı	Görec
1	125	Kontrol	E.K.T.
1	125	Kontrol	Böğ
Tarih	15/05/2014	Tumba yapıları ve detay Resimleri	Notanın Altına KAYLI Resim no: 2.1.10

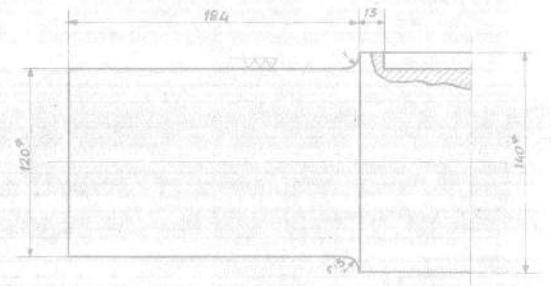
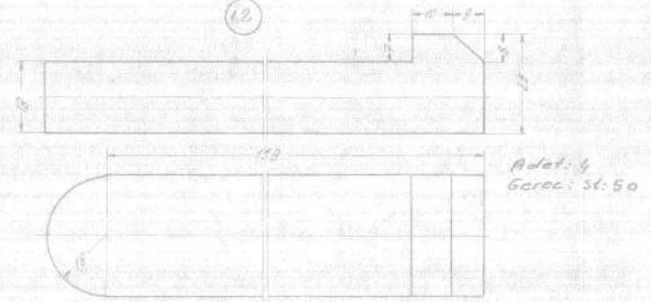
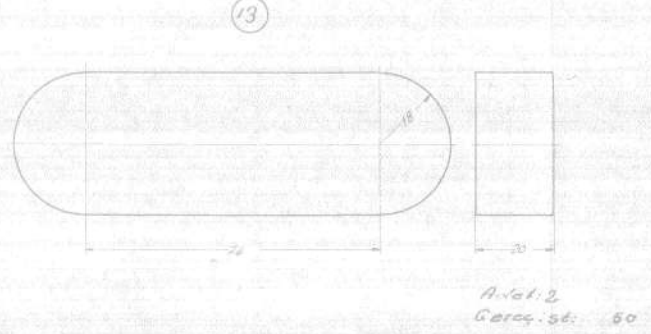
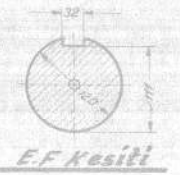
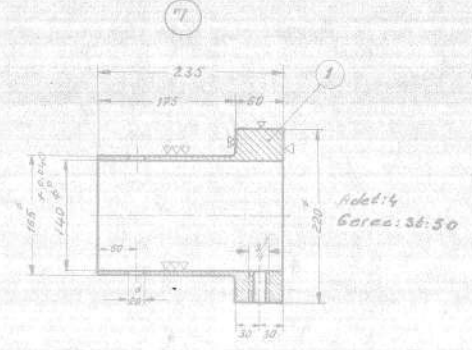
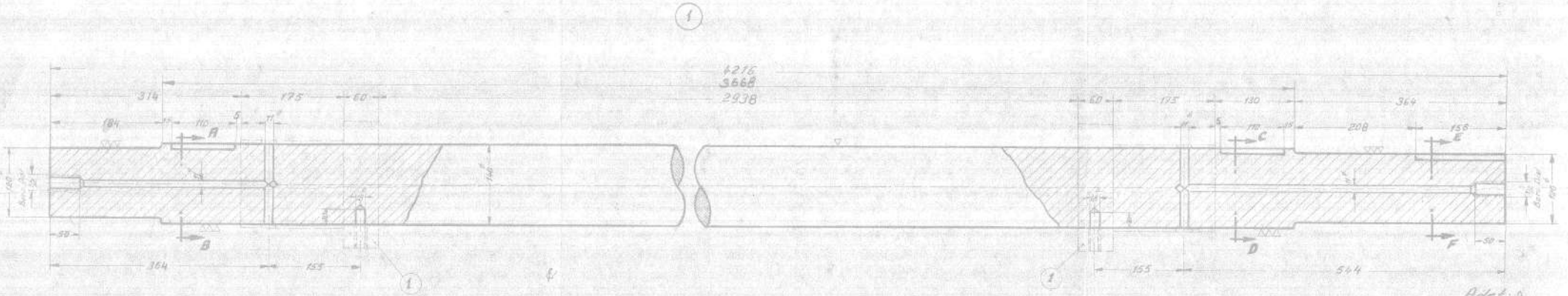

Not: 1 Numaralı Bute Yatacın Sadece 4 adet.

Gerec çelik	Ürün Adı Tarih: 27.4.1968 Model:	Resim Kontrol: Tarih:	Yazan Mehmet Güneş Vedat Kırdaç	Çizim Tarih:	E.K. KÖZLU BÖLGESİ
Ölçek 1:5 7/1	Tumba Mili				Resim No: A-18-1

2

~ ∇, (∇∇)

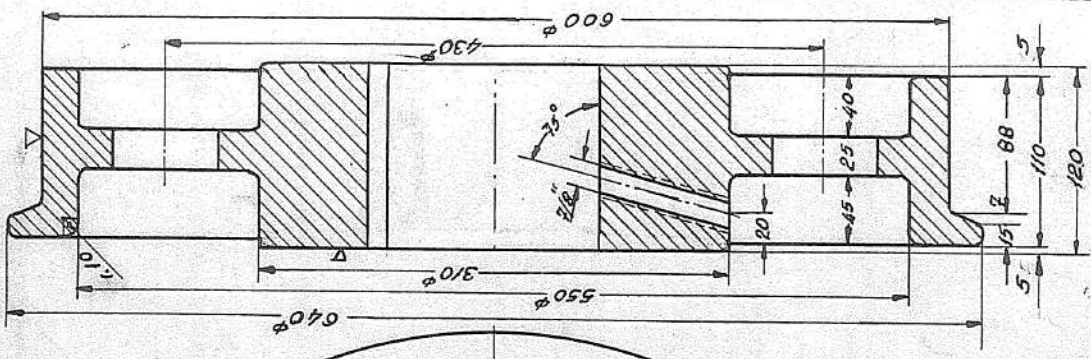
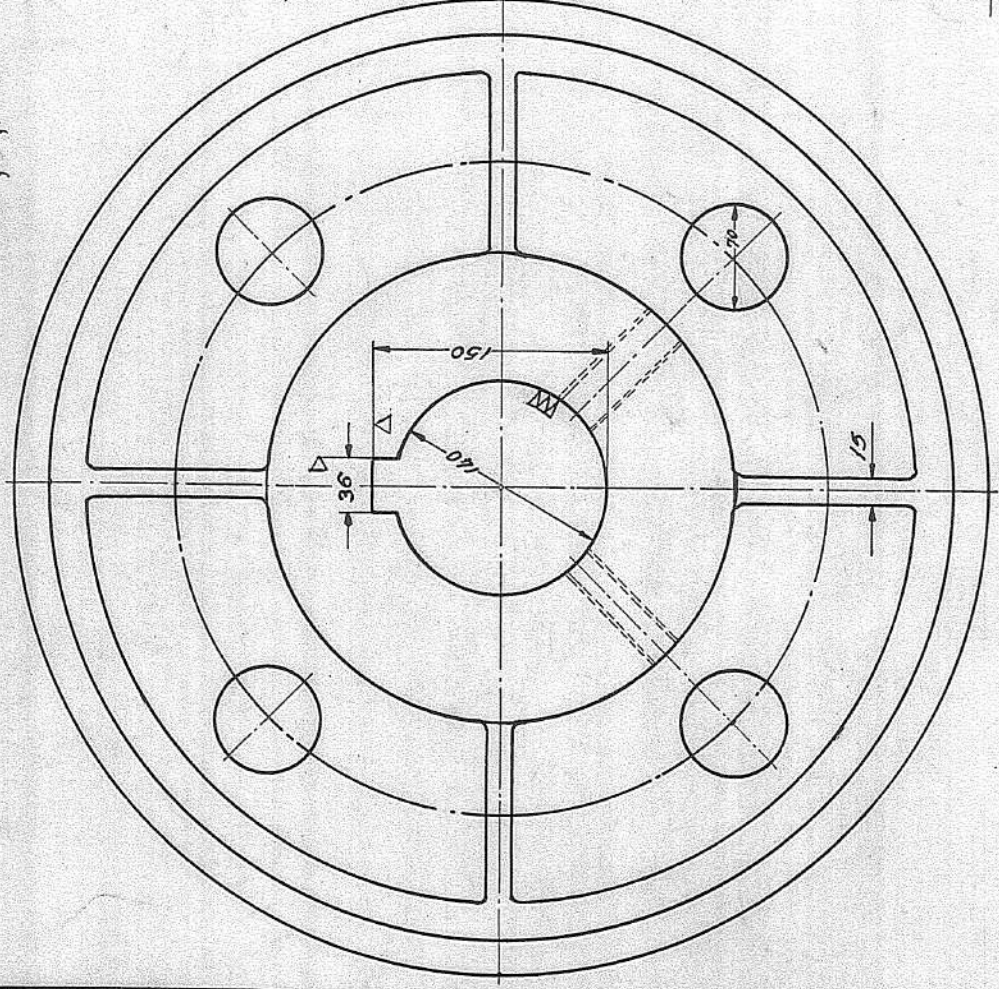

15

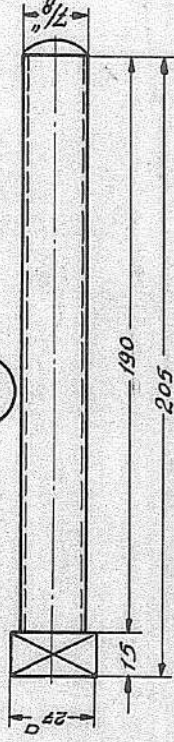

16 ∇, ∇∇

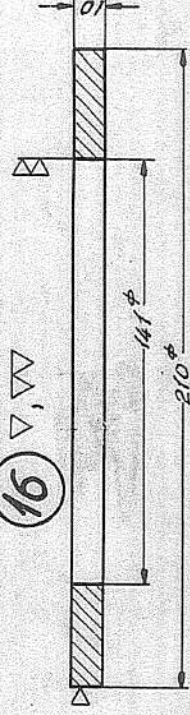

16	Saplama	15	St 42
1	Rondela	16	St 37
8	Sabit bandaj	2	BS 52
Adet	Parça Adı	Resim No	Gereç
Ölçek	Gizen Emir	E. K. i. (A)	
1:5 1:25	Mehmet Güreçli	Mekonik Atölye	
Tarih	"	VEDAT KIRDAĞ	
19/5/66	Tumba sabit bandaj ve parça.	KOZLU	
	Resimleri	Resim N. A-1-8-2/15/16	

